

**NEW**

# RIEGL VUX<sup>®</sup>-240

- **laser pulse repetition rate up to 1.8 MHz**
- **measurement rate up to 1,500,000 meas./sec**
- **scan speed up to 400 lines/second**
- **operating flight altitude up to 1,400m / 4,600 ft**
- **Field of View up to 75°**
- **perfectly linear and parallel scan lines**
- **cutting edge RIEGL technology providing:**
  - **echo signal digitization**
  - **multiple target capability**
  - **online waveform processing**
  - **multiple-time-around processing**
- **compact & lightweight**
- **easily mountable to unmanned platforms (UAVs) and to helicopters, gyrocopters, and other small manned aircrafts**
- **mechanical and electrical interface for INS/GNSS integration (optional)**
- **interfaces for up to 4 optional cameras**
- **scan data storage on internal 240 GByte SSD Memory**

The **RIEGL VUX-240** is a lightweight airborne laser scanner, especially designed for use on UAS/UAV/RPAS and small manned aeroplanes or helicopters.

With its wide field of view of 75 degrees and an extremely fast data acquisition rate of up to 1.8 MHz, the instrument is perfectly suited for high point density corridor mapping applications.

The VUX-240 makes use of **RIEGL's** unique Waveform-LiDAR technology, allowing echo digitization and online waveform processing. Multi-target resolution is the basis for penetrating even dense foliage.

A continuously rotating polygon mirror wheel enables scan speeds of up to 400 lines per second, for efficiently covering large areas when operated from fast UAVs or aircrafts.

The scanner provides an internal data storage capacity of 240 GByte and is equipped with interfaces for an external IMU/GNSS system as well as to control up to four external cameras. WLAN enables direct access to the laser scanner for changing configuration settings and checking the system status.

## Typical applications include

- **Corridor Mapping: Power Line, Railway Track and Pipeline Inspection**
- **Topography in Open-Cast Mining**
- **Surveying of Urban Environments**
- **Archeology and Cultural Heritage Documentation**
- **Agriculture & Forestry**



visit our website  
[www.riegl.com](http://www.riegl.com)



## Laser Product Classification

Class 1 Laser Product  
according to IEC 60825-1:2014



The following clause applies for instruments delivered into the United States: Complies with 21 CFR 1040.10 and 1040.11 except for deviations pursuant to Laser Notice No. 50, dated June 24, 2007

## Range Measurement Performance

### Measuring Principle

time of flight measurement, echo signal digitization, multiple target capability, online waveform processing, multiple-time-around-processing

Laser Pulse Repetition Rate PRR <sup>1)</sup>	150 kHz	300 kHz	600 kHz	1200 kHz	1800 kHz
Max. Measuring Range <sup>2) 3)</sup> natural targets $\rho \geq 20\%$ natural targets $\rho \geq 60\%$	1200 m 1900 m	850 m 1400 m	650 m 1050 m	450 m 750 m	350 m 650 m
Max. Operating Flight Altitude AGL <sup>2) 4)</sup> @ $\rho \geq 20\%$	900 m (2950 ft)	600 m (1950 ft)	500 m (1650 ft)	350 m (1150 ft)	250 m (800 ft)
@ $\rho \geq 60\%$	1400 m (4600 ft)	1050 m (3450 ft)	900 m (2950 ft)	550 m (1800 ft)	500 m (1650 ft)
Max. Number of Targets per Pulse <sup>5)</sup>	15	15	15	9	6

1) Rounded average PRR.  
2) Typical values for average conditions and average ambient brightness. In bright sunlight, the max. range is shorter than under an overcast sky.  
3) The maximum range is specified for flat targets with size in excess of the laser beam diameter, perpendicular angle of incidence, and for atmospheric visibility of 23 km. Range ambiguities have to be resolved by multiple-time-around processing.  
4) Effective FOV 75°, additional roll angle  $\pm 5^\circ$ .  
5) If the laser beam hits, in part, more than one target, the laser's pulse power is split accordingly. Thus the achievable range is reduced.

## Minimum Range

Accuracy <sup>7) 9)</sup>

Precision <sup>8) 9)</sup>

Laser Pulse Repetition Rate <sup>1) 10)</sup>

Max. Effective Measurement Rate <sup>1)</sup>

Echo Signal Intensity

Laser Wavelength

Laser Beam Divergence

Laser Beam Footprint (Gaussian Beam Definition)

5 m

20 mm

15 mm

up to 1800 kHz

up to 1,500,000 meas./sec. (@ 1800 kHz PRR & 75° FOV)

for each echo signal, high-resolution 16 bit intensity information is provided

near infrared

0.35 mrad <sup>11)</sup>

35 mm @ 100 m, 175 mm @ 500 m, 350 mm @ 1000 m

- 7) Accuracy is the degree of conformity of a measured quantity to its actual (true) value.  
8) Precision, also called reproducibility or repeatability, is the degree to which further measurements show the same result.

9) One sigma @ 150 m range under RIEGL test conditions.

10) User selectable.

11) Measured at the 1/e<sup>2</sup> points. 0.35 mrad corresponds to an increase of 35 mm of beam diameter per 100 m distance.

## Scanner Performance

Scanning Mechanism

Scan Pattern

Field of View (selectable)

Scan Speed (selectable)

Angular Step Width  $\Delta \theta$  (selectable)

between consecutive laser shots

Angle Measurement Resolution

Scan Sync (optional)

rotating polygon mirror

parallel scan lines

$\pm 37.5^\circ = 75^\circ$

40 - 400 lines/sec

$0.002^\circ \leq \Delta \theta \leq 0.24^\circ$  <sup>12) 13)</sup>

0.001°

scanner rotation synchronization

## Data Interfaces

Configuration

Scan Data Output

GNSS Interface

Internal Memory

External Camera

External IMU & GNSS

LAN 10/100/1000 Mbit/sec, WLAN

LAN 10/100/1000 Mbit/sec

Serial RS232 interface for data string with GNSS-time information,

TTL input for 1PPS synchronization pulse

240 GByte SSD

4x power, RS232, 1pps, trigger, exposure, TTL input/output

combined connector with power supply and

signal interface to external IMU & GNSS

## General Technical Data

Power Supply Input Voltage / Consumption <sup>14)</sup>

Main Dimensions (L x W x H)

Weight

Humidity

Protection Class

Max. Flight Altitude (operating & not operating)

Temperature Range

18 - 34 V DC / typ. 65 W

292 mm x 164 mm x 185 mm (without IMU/GNSS)

380 mm x 164 mm x 185 mm (with IMU/GNSS)

$\leq 3.8$  kg (without IMU/GNSS),  $\leq 4.5$  kg (with IMU/GNSS)

max. 80 % non condensing @ 31°C

IP64, dust and splash-proof

18 500 ft (5 600 m) above MSL (Mean Sea Level)

-10°C up to +40°C (operation) / -20°C up to +50°C (storage)

- 12) The angular step width depends on the selected laser PRR.  
13) The maximum angular step width is limited by the maximum scan rate.

14) without external IMU/GNSS

to be continued at page 6

## PRR = 150 kHz

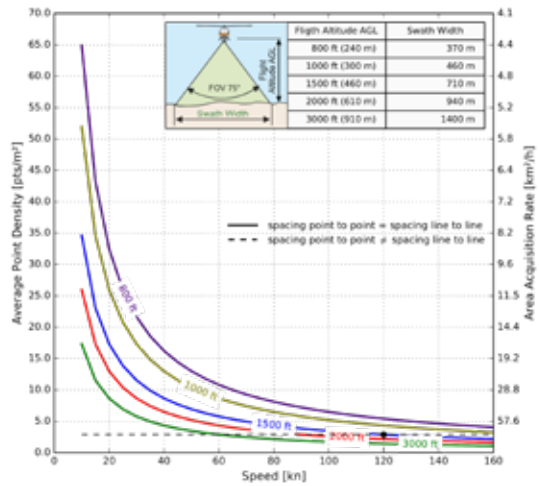
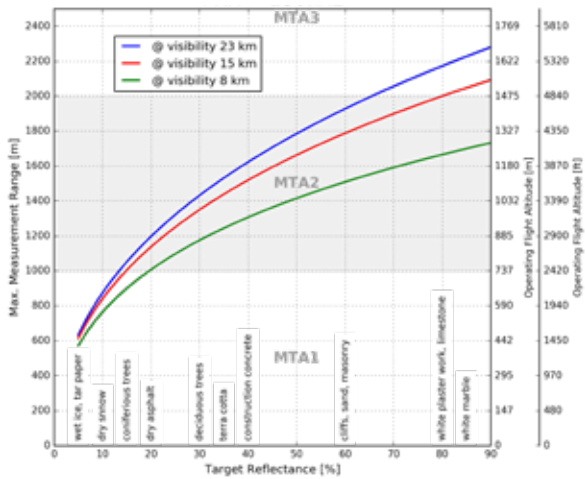

**Example:** VUX-240 at 150,000 pulses/sec, laser power level 100%  
Altitude = 1,500 ft AGL, Speed 120 kn

**Results:** Point Density ~ 3 pts/m<sup>2</sup>

## PRR = 300 kHz

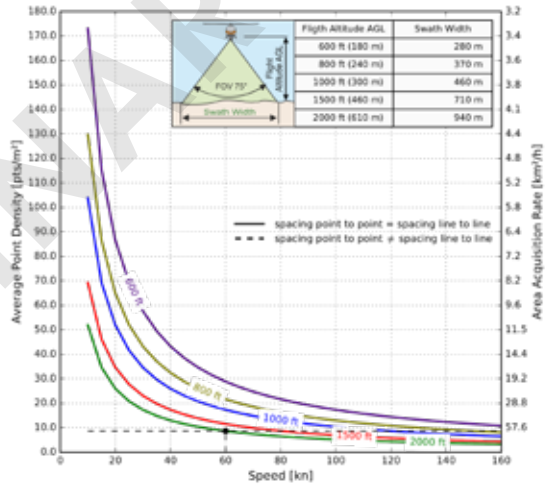
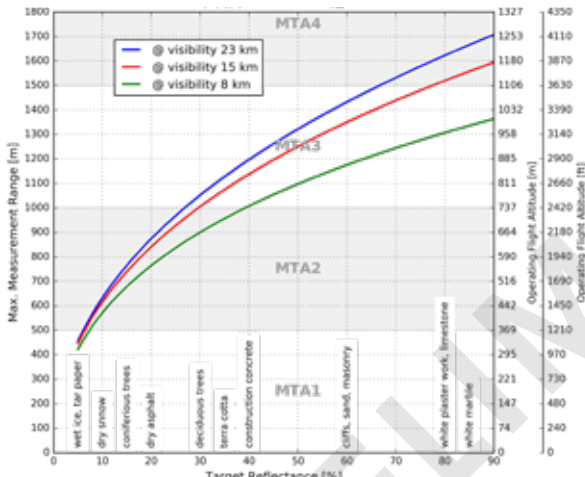

**Example:** VUX-240 at 300,000 pulses/sec, laser power level 100%  
Altitude = 2,000 ft AGL, Speed 60 kn

**Results:** Point Density ~ 9 pts/m<sup>2</sup>

## PRR = 600 kHz

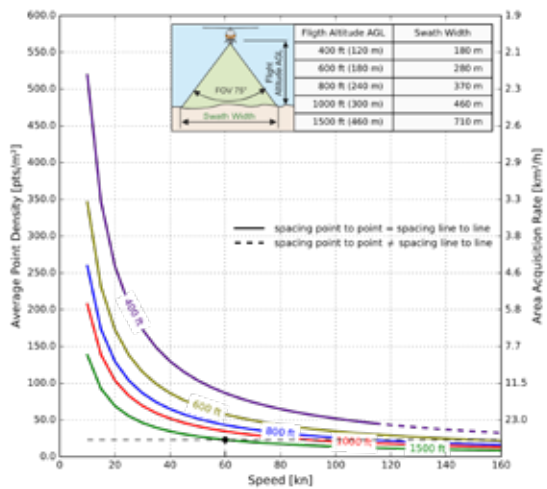
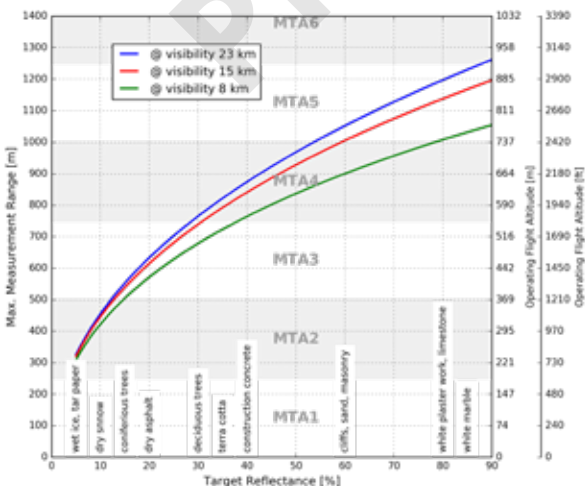

**Example:** VUX-240 at 600,000 pulses/sec, laser power level 100%  
Altitude = 1,500 ft AGL, Speed 60 kn

**Results:** Point Density ~ 22 pts/m<sup>2</sup>

### The following conditions are assumed for the Operating Flight Altitude AGL

- ambiguity resolved by multiple-time-around (MTA) processing
- roll angle ±5°
- target size ≥ laser footprint
- average ambient brightness
- operating flight altitude given at a FOV 75°

# Maximum Measurement Range & Point Density RIEGL VUX<sup>®</sup>-240

PRR = 1200 kHz

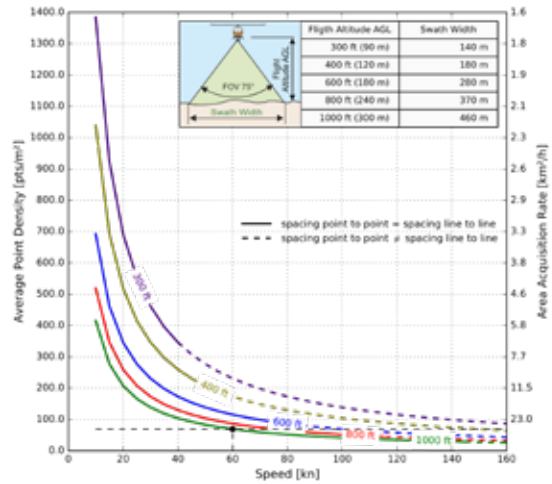
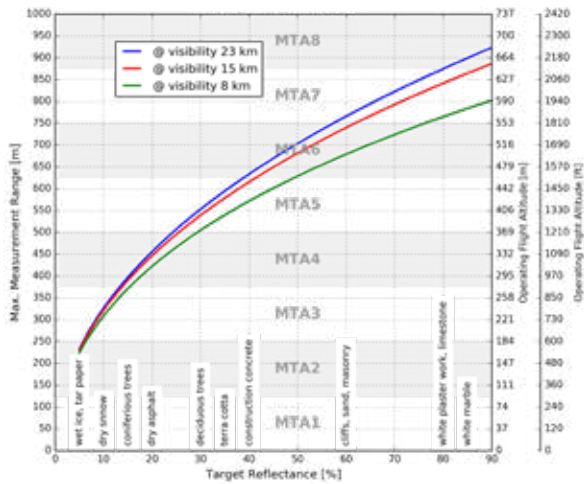

**Example:** VUX-240 at 1,200,000 pulses/sec, laser power level 100%  
Altitude = 1,000 ft AGL, Speed 60 kn

**Results:** Point Density ~ 60 pts/m<sup>2</sup>

PRR = 1800 kHz

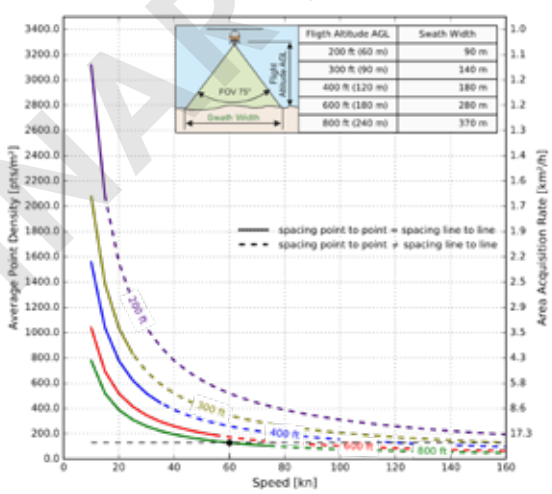
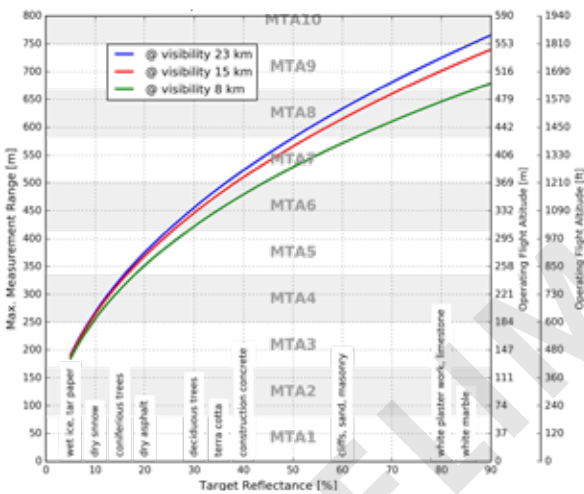

**Example:** VUX-240 at 1,800,000 pulses/sec, laser power level 100%  
Altitude = 800 ft AGL, Speed 60 kn

**Results:** Point Density ~ 120 pts/m<sup>2</sup>

**The following conditions are assumed for the Operating Flight Altitude AGL**

- ambiguity resolved by multiple-time-around (MTA) processing
- target size ≥ laser footprint
- average ambient brightness
- roll angle ±5°
- operating flight altitude given at a FOV of 75°

bottom view

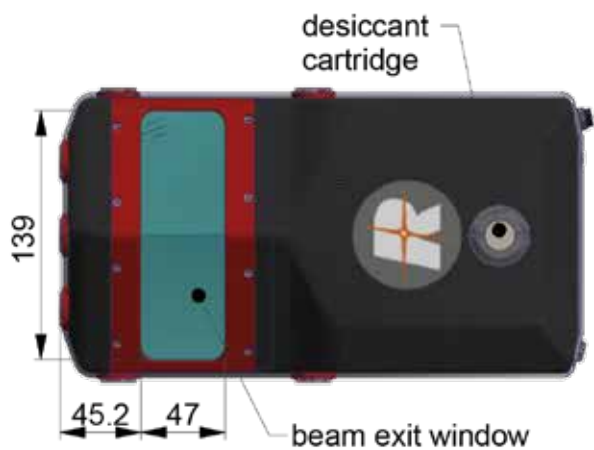

rear view

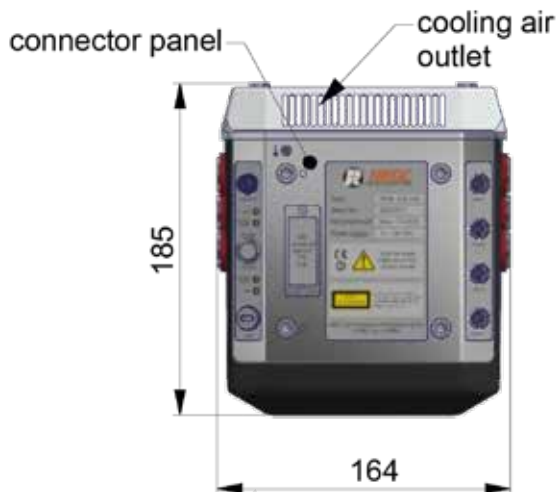

side view



front view

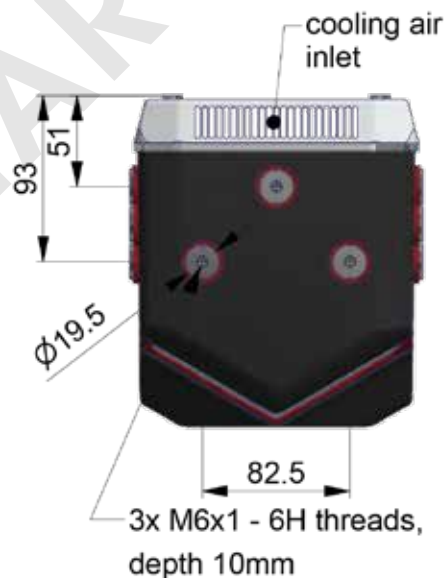

top view

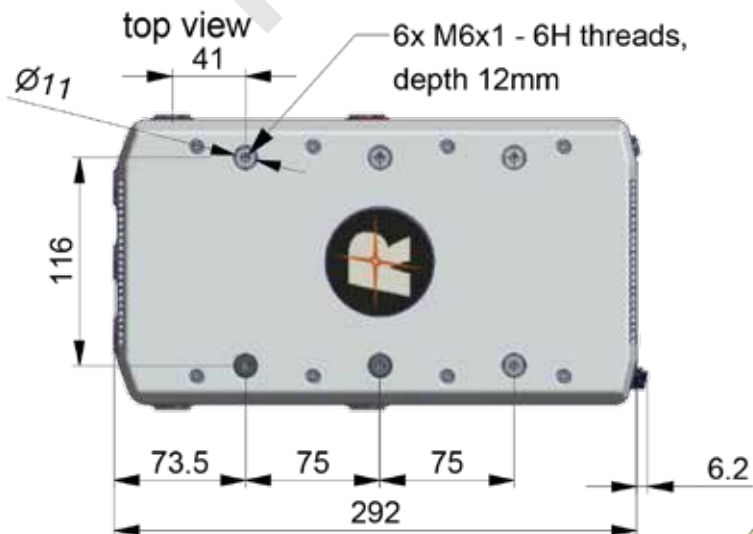

front view with FOV

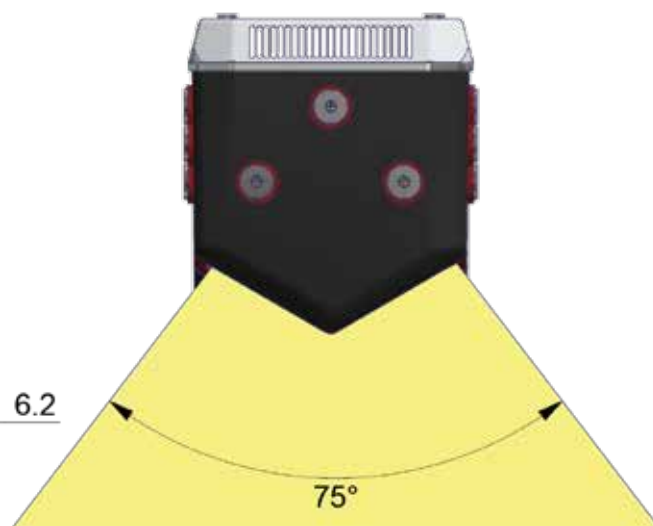

all dimensions in mm

# RIEGL VUX®-240 Additional Equipment and Integration (optional)

## External IMU & GNSS (optional)

recommended: Applanix APX-20 UAV <sup>1)</sup>

IMU Accuracy <sup>2)</sup>

Roll, Pitch

0.015°

Heading

0.035°

IMU Sampling Rate

200 Hz

Position Accuracy (typ.)

horizontal

< 0.05m

vertical

< 0.1 m

- 1) See technical details at the according Applanix datasheet.  
2) Accuracy specifications for post-processed data.

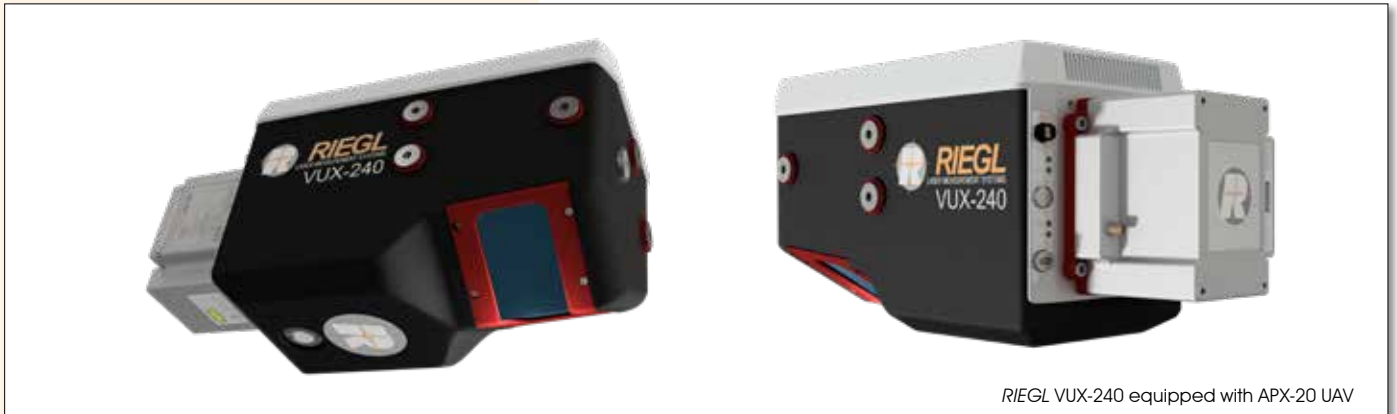

PRELIMINARY

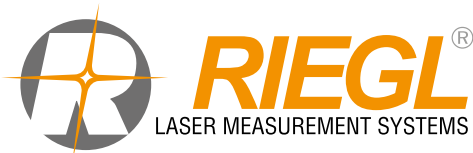

**RIEGL Laser Measurement Systems GmbH**  
Riedenburgstraße 48  
3580 Horn, Austria  
Phone: +43 2982 4211 | Fax: +43 2982 4210  
office@riegl.co.at  
www.riegl.com

**RIEGL USA Inc.**  
Orlando, Florida | info@rieglusa.com | www.rieglusa.com  
**RIEGL Japan Ltd.**  
Tokyo, Japan | info@riegl-japan.co.jp | www.riegl-japan.co.jp  
**RIEGL China Ltd.**  
Beijing, China | info@riegl.cn | www.riegl.cn

[www.riegl.com](http://www.riegl.com)